

Project: \_\_\_\_\_

Date: \_\_\_\_\_

Catalog #: \_\_\_\_\_

Notes: \_\_\_\_\_

### Key Features & Benefits:

- Universal AC Input / Full Range (up to 305 VAC)
- Built-in Active PFC Function
- Protections: Short Circuit / Over Voltage / Over Temperature
- Suitable for Dry / Damp Locations
- Easy Installation with ESL Vision Quick Connect Series
- 7 Year Warranty



### Technical Specifications:

Input	Output	Environment
Input Voltage: 100 - 277 VAC	DC Voltage: 36 VDC	Working Temperature: -20 ~ 50°C
Power Factor: 0.98 / 120 VAC, 0.90 / 277 VAC	Rated Current: 435 mA	Max Case Temperature: 81°C
Total Harmonic Distortion: 20%	Rated Power: 18W	Working Humidity: 20 -70% RH
Frequency Range: 47~63 Hz	Voltage Range: 32 - 48 VDC	
Efficiency: 87%	Line Regulation: 3%	
AC Current: .150 A / 120 VAC, .065 A / 277 VAC	Load Regulation: 2%	

### Driver Dimensions:

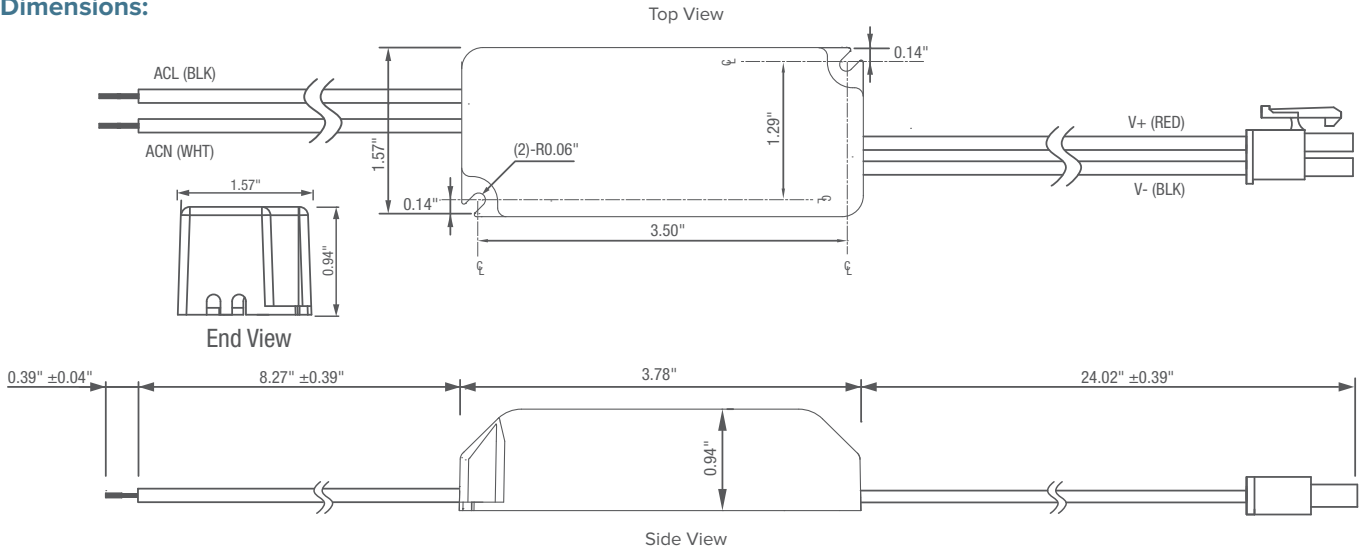

Example Part Number: **ESL-DQC1-18W-1L**

<b>ESL</b>	-	<b>DQC1</b>	-	<b>18W</b>	-	<b>1L</b>
ESL		DRIVER		WATTS		DC OUTPUT
		DQC1		10W 18W 12W 22W 13W 30W 15W 36W		1L