

Key Features & Benefits:

- Housing:
 - Rugged anodized aluminum housing
 - Finish formulated for long-lasting color and durability
 - Industry leading thermal management design for maximum operational life
- Optical Grade Polycarbonate Lens:
 - UV stabilized lens
 - Prismatic molded lens for optimal uniformity
 - Impact resistant
- Distribution Options:
 - Type IV (Standard)
 - Type III
 - Type V
- Limited 10 Year Warranty
- L70 Lifetime > 100,000 hours - TM-21, @77°F
- Operational Temperature: -40°F to 130°F
- 0-10v Dimming Optional
- Photocell Options:
 - On/Off (Utilized with 3-pin receptacle)
 - Dusk-to-Dawn* (Dimming utilized with 5 or 7-pin receptacle)
- Motion Sensor Options:
 - On/Off and dimming capable*
- Dark Sky IDA Compliant - 3000K Direct Arm Mount is Required



Project: _____ Date: _____

Catalog #: _____

Notes: _____

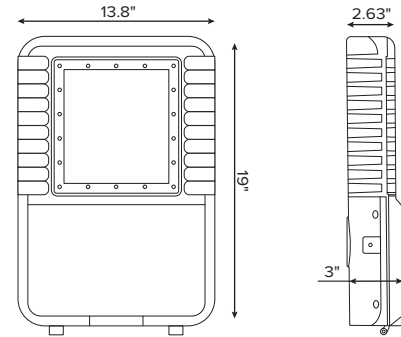

* Please see ESL Vision's dimming control sheet (page 3) for more details



Technical Specifications:

- Lumen Output: Up to 35,240 Lumens
- Efficacy (lm/W): Up to 133 Lumens per Watt
- Correlated Color Temperature (CCT): 4000K, 5000K**
- Color Rendering Index (CRI): >70
- Dimensions (LxWxH): 19" x 13.8" x 3" (without mounting)
- Total Weight (lbs): 25.4
- Effective Projected Area:
 - EPA = 1.22 (Direct Arm Mount)

** 3000K is DLC listed and available upon request

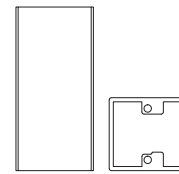

Direct Arm Mount

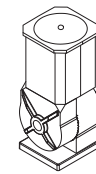

Slip Fitter

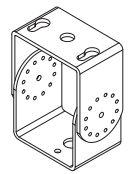

Yoke Mount

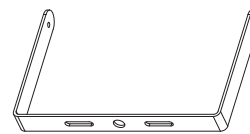

Trunnion Mount

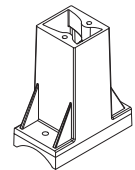

RDM

For more detailed information on the mounting options above please see the Area Light Mounting Specification Sheet

Catalog Data:

ITEM#	WATTS	LUMEN OUTPUT	EFFICACY (lm/W)	KELVIN	INPUT VOLTAGE
ESL-AL-265W-140	265W	32,745	124	4000K	120-277V
ESL-AL-265W-140-HV	265W	34,345	130	4000K	347-528V
ESL-AL-265W-150	265W	33,598	127	5000K	120-277V
ESL-AL-265W-150-HV	265W	35,240	133	5000K	347-528V

†Not All Part Numbers DLC Qualified. For a Complete Listing Please Consult the DLC Qualified Products List (QPL).

Lumen Ambient Temperature (LAT) Multipliers:

AMBIENT		LUMEN MULTIPLIER
0 °C	32 °F	1.02
10 °C	50 °F	1.01
20 °C	68 °F	1
25 °C	77 °F	1
30 °C	86 °F	1
40 °C	104 °F	0.99

Electrical Load:

SYSTEM WATTS	CURRENT					
	120	208	240	277	347	480
75	0.63	0.36	0.31	0.27	0.22	0.16
120	1.00	0.58	0.50	0.43	0.35	0.25
150	1.25	0.72	0.63	0.54	0.43	0.31
185	1.54	0.89	0.77	0.67	0.53	0.39
230	1.92	1.11	0.96	0.83	0.66	0.48
265	2.21	1.27	1.10	0.96	0.76	0.55

Distribution Options:

The images below showcase the three distribution types and suggested uses. ESL Vision's lighting design engineers can help create custom lighting layouts for your jobs free of charge.

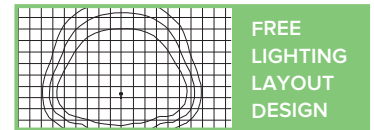

TYPE III

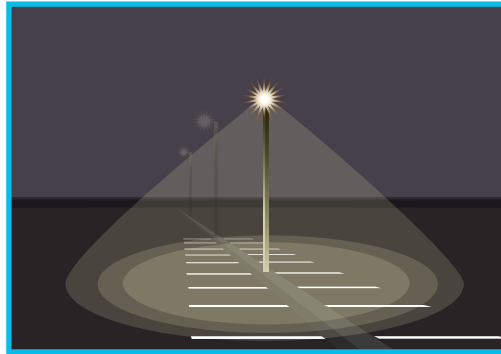

TYPE V

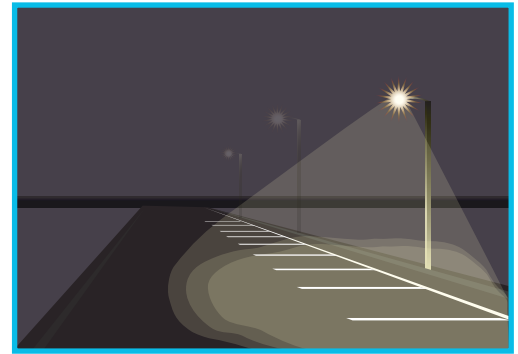

TYPE IV (Standard)

Ordering Guide:

ESL	-	AL	-	265W	-	1	-		-		-		-		-	
ESL		TYPE		WATTS		GENERATION		KELVIN		VOLTAGE		HOUSING		MOUNTING		LENS
		AL (Area Light)		75W 185W 110W 230W 150W 265W		1 (1st Generation)		30 (3000 Kelvin)* 40 (4000 Kelvin) 50 (5000 Kelvin)		Blank (120-277V) HV (347-528V)		BZ (Bronze) BK (Black)** WH (White)** GR (Grey)** OT (Other)**		SF (Slip Fitter) DM (Direct Arm Mount) TM (Trunnion Mount) YM (Yoke Mount) RDM-4 (Round 4" Pole Mount) RDM-5 (Round 5" Pole Mount) RDM-6 (Round 6" Pole Mount)		Type IV (Standard) Type V Type III

* 3000K is DLC listed and available upon request
** Not typically stocked

Options (Add as Suffix):

- 5OCC (Occupancy Sensor)
- PCOF3 (3 Pin Receptacle on/off photocell)
- PCOF5 (5 Pin Receptacle on/off photocell)
- PCOF7 (7 Pin Receptacle on/off photocell)
- PCDD5 (5 Pin Receptacle dusk-to-dawn dimming photocell)
- PCDD7 (7 Pin Receptacle dusk-to-dawn dimming photocell)
- PCSC3 (3 pin receptacle with shorting cap)
- PCSC5 (5 pin receptacle with shorting cap)
- PCSC7 (7 pin receptacle with shorting cap)

Options (Order Separately):

- ESL-RPC3 (Three Pin twist lock Receptacle)
- ESL-RPC5 (Five Pin twist lock Receptacle)
- ESL-RPC7 (Seven Pin twist lock Receptacle)
- ESL-PCOF (on/off photocell)
- ESL-PCDD (dusk to dawn photocell)
- ESL-PCSC (Shorting Cap)
- ESL-AL1SShield-xx (House Side Shield for 75W to 150W) Field Installed**
- ESL-AL1LSShield-xx (House Side Shield for 185W to 265W) Field Installed**
- ESL-5OCC
- ESL-REM101

For other mounting options please see our post mount accessories

** Please specify housing color

House Side Shield:

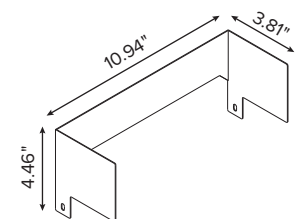

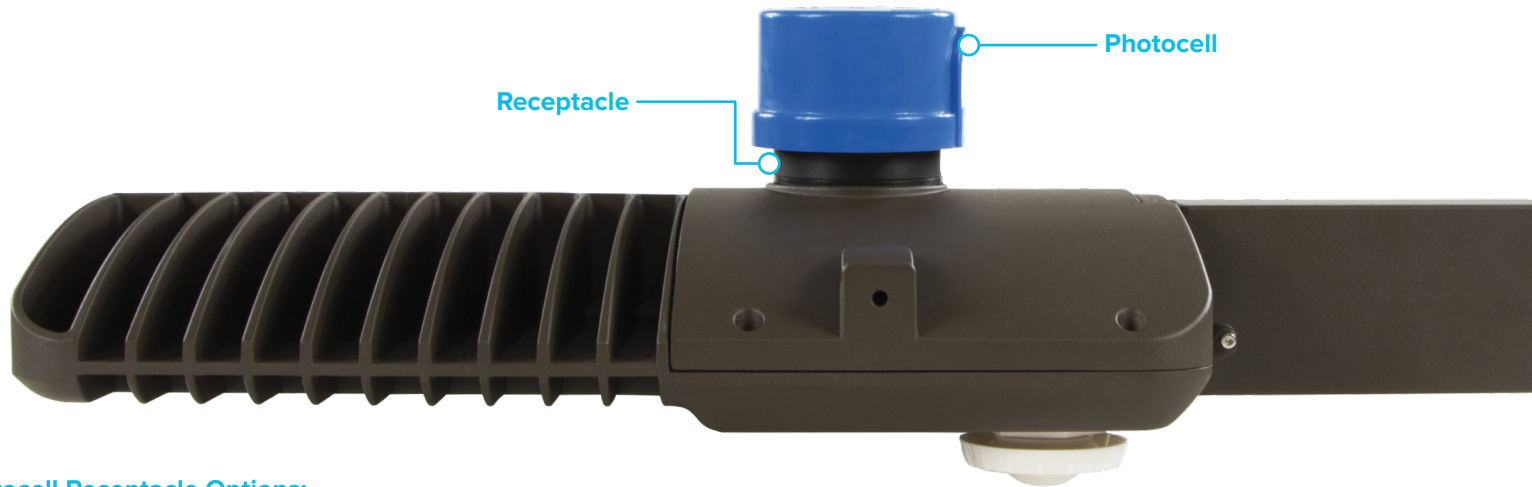

Photocell Receptacle Options:

The Area Light Series has the ability to work with a 3-Pin, 5-Pin or 7-Pin receptacle.



ESL-RPC3

3-Pin receptacles are used exclusively for on/off control.



ESL-RPC5

5-Pin receptacles offer on/off control, dimming via dusk-to-dawn photocell, and the ability to work with network controls such as Echelon, Daintree and EnOcean.



ESL-RPC7

7-Pin receptacles also offer on/off control, dimming via dusk to dawn, network control integration, and adds an extra set of pins to “future proof” your Area Light purchase.

Photocell Options:



ESL-PCOF

ESL-PCOF is a standard on/off photocell that has been frequently used in the market with antiquated technologies.



ESL-PCDD

ESL-PCDD dusk to dawn photocell offers a controlled ramp up period to full brightness at dusk while slowly dimming at dawn. A 5-Pin or 7-Pin receptacle is needed to work with the ESL-PC-DD.



ESL-PCSC

ESL-PCSC - A shorting cap that is used for those projects where you have the flexibility to decide in the future on how to control the ESL Vision Area Light.

Please contact the factory for more information about 3rd party network photocell controls that can be integrated

Occupancy Sensor:

The ESL Vision Area Light Series has integrated occupancy control (ESL-50CC) options. These can be factory programmed or set in the field with the ESL-REM101 remote system. The 50CC allows for on/off settings or controlled dimming to 10/20/30% in perpetuity. There are 6 time settings (10 seconds to 60 minutes) available upon occupancy detection to bring the fixture back to 100% light setting. The 40 foot range of the 50CC allows it to be used for virtually any application.



For Mounting Heights up to 40'

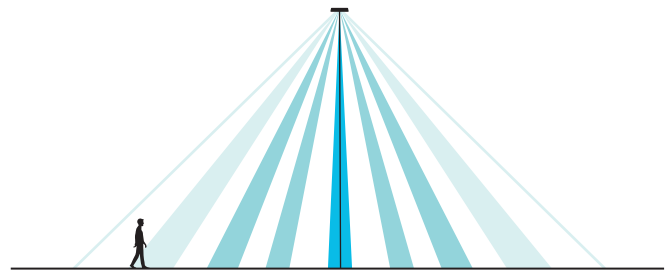
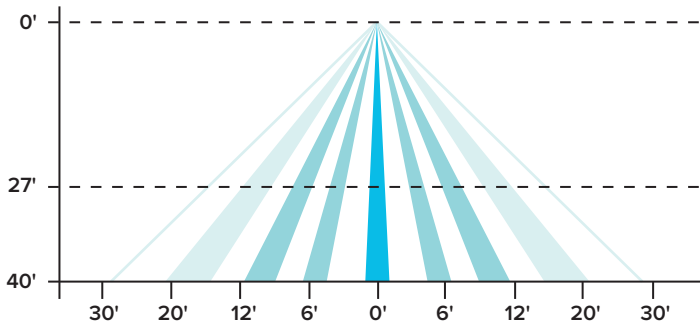

Control Overview:

CONTROL OPTIONS	RPC-3 (3 Wire)	RPC-5 (5 wire)	RPC-7 (7 wire)
Photo Control Only (On/Off)	✓ Yes	⤵ Dimming Capable	⤵ Dimming Capable
Dusk to Dawn Photocell	⊘ No	✓ Yes	✓ Yes
Occupancy Sensors	📱 On/Off	⤵ Dimming Capable	⤵ Dimming Capable



75, 110 and 150 Watts

ITEM#	WATTS	LUMEN* OUTPUT	EFFICACY* (lm/W)	KELVIN	INPUT VOLTAGE
ESL-AL-75W-1XX-YY-ZZ	75W	10,678	141	5000K	120-277V
ESL-AL-75W-1XX-HVYY-ZZ	75W	10,395	139	5000K	347-528V

ITEM#	WATTS	LUMEN* OUTPUT	EFFICACY* (lm/W)	KELVIN	INPUT VOLTAGE
ESL-AL-110W-1XX-YY-ZZ	110W	15,178	129	5000K	120-277V
ESL-AL-110W-1XX-HV-YY-ZZ	110W	14,944	128	5000K	347-528V

ITEM#	WATTS	LUMEN* OUTPUT	EFFICACY* (lm/W)	KELVIN	INPUT VOLTAGE
ESL-AL-150W-1XX-YY-ZZ	150W	19,002	124	5000K	120-277V
ESL-AL-150W-1XX-HV-YY-ZZ	150W	18,671	122	5000K	347-528V



185, 230 and 265 Watts

ITEM#	WATTS	LUMEN* OUTPUT	EFFICACY* (lm/W)	KELVIN	INPUT VOLTAGE
ESL-AL-185W-1XX-YY-ZZ	185W	25,454	140	5000K	120-277V
ESL-AL-185W-1XX-HV-YY-ZZ	185W	25,683	139	5000K	347-528V

ITEM#	WATTS	LUMEN* OUTPUT	EFFICACY* (lm/W)	KELVIN	INPUT VOLTAGE
ESL-AL-230W-1XX-YY-ZZ	230W	29,373	131	5000K	120-277V
ESL-AL-230W-1XX-HV-YY-ZZ	230W	30,330	131	5000K	347-528V

ITEM#	WATTS	LUMEN* OUTPUT	EFFICACY* (lm/W)	KELVIN	INPUT VOLTAGE
ESL-AL-265W-1XX-YY-ZZ	265W	33,598	127	5000K	120-277V
ESL-AL-265W-1XX-HV-YY-ZZ	265W	35,240	133	5000K	347-528V

KEY:

XX = 40 or 50 for Kelvin Temperature

YY = Housing Color: Bronze (BZ), White (WH), Black (BK), Gray (GR)

ZZ = Mounting Options: Slip Fitter (SF), Direct Arm (DM), Trunnion (TM), Yoke Mount (YM)

* 5000K Lumen and Efficacy data listed. See specification sheet for other kelvin information.

Alternative Kelvins (3000K, 4000K, and 5700K) available upon request. See specification sheet for more information.