

Key Features & Benefits:

- Wet Location Approved
- Omnidirectional
- Rated for Fully Enclosed Fixtures



Technical Specifications:

- Power: 80 Watts
- Lumen Output: Up to 10,640 Lumens
- Efficacy (lm/W): Up to 133 Lumens per Watt
- Kelvin: 3000K, 4000K, 5000K
- CRI: >80
- Input Voltage: 120-277 VAC
- Life Span: 40,000 Hours
- Beam Angle: 300°
- Dimensions(ØxH): 5.87" x 9.25"
- Weight(lbs): 3.8 lbs
- Base Type: E39X
- Operating Temperature: -4 ~ 149°F (-20 ~ 65°C)
- Power Factor: >0.95
- Total Harmonic Distortion (THD): < 20%

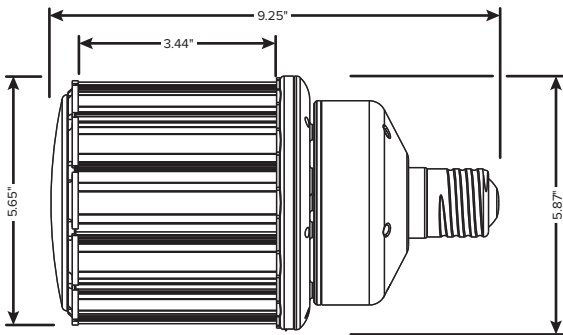

Project: _____

Date: _____

Catalog #: _____

Notes: _____



No Fans



No Noise



No Bugs

ITEM #	WATTS	LUMEN OUTPUT	EFFICACY (lm/W)	KELVIN
ESL-CL-80W-330M	80W	9,070	124	3000K
ESL-CL-80W-340M	80W	10,400	130	4000K
ESL-CL-80W-350M	80W	10,640	133	5000K

Ordering Guide:

Example Part Number: **ESL-CL-80W-330M**

ESL	-	CL	-	80W	-	3	-	M
ESL		TYPE		WATTS		GENERATION		BASE
		CL		80W (80 Watts)		3 (3RD Generation)		M (E39X)
						30 (3000K) 40 (4000K) 50 (5000K)		

Additional Options:



ESL-SP-277 (Surge Protector up to 277 VAC)