

Dip Switch Programming:

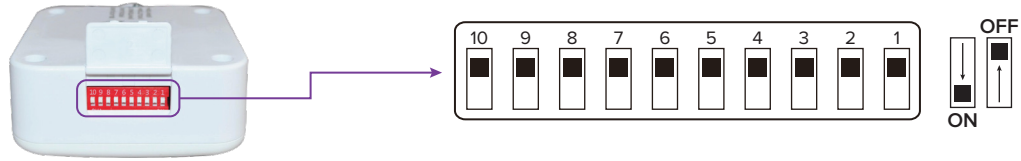

Detection Range (Sensitivity):

Detection range is the term used to describe the radii of the circular detection zone after sensor has been mounted and installed at a height of 50ft.

SENSITIVITY

1	2	%
OFF	OFF	20%
OFF	ON	50%
ON	OFF	75%
ON	ON	100%

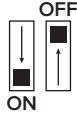

Hold Time:

The light can be set to stay ON for any period of time between approximately 10 seconds to a maximum of 60 minutes. Any detection of movement before the programmed hold time elapses and the timer with re-start. It is recommended to select the shortest time for adjusting the detection zone and for performing the walk test.

TIME

3	4	⊙
OFF	OFF	10s
OFF	ON	10min
ON	OFF	30min
ON	ON	60min

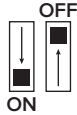
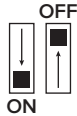

Photo Control:

The photocell light settings can be adjusted to: Off = no change in light will affect occupancy. At 10lux (1 fc) fixture will go off. At 30lux (3 fc) fixture will go off. At 50lux (5 fc) fixture will go off.

LIGHT

5	6	lux
OFF	OFF	☼
OFF	ON	10lux
ON	OFF	30lux
ON	ON	50lux



Stand-by Light Level:

When no movement is detected after hold time elapses, the light dims to stand-by level (10%/30%/50%).

STAND-BY LEVEL

7	8	%
OFF	OFF	0%
OFF	ON	10%
ON	OFF	30%
ON	ON	50%



Stand-by Time:

Light will switch to OFF after the stand-by time of (1min/30min/60min) has elapsed.

STAND-BY TIME

9	10	⊙
OFF	OFF	+∞
OFF	ON	1min
ON	OFF	30min
ON	ON	60min



NOTE: If you set the STAND-BY LEVEL at 0%, and the STAND-BY TIME at + ∞ it becomes an ON/OFF function.

Remote Control Programming:

The ESL-REM-100 (Sold Separately) can be use to program the 2OCC-HDD remotely. With a range of 50ft this allows for the flexibility to re-program for any reason, at any time. Please see REM-100 spec sheet and/or instruction guide for more detailed information.



Dimensions:

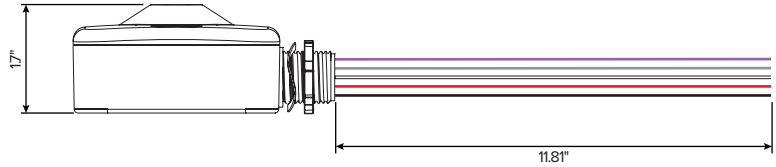
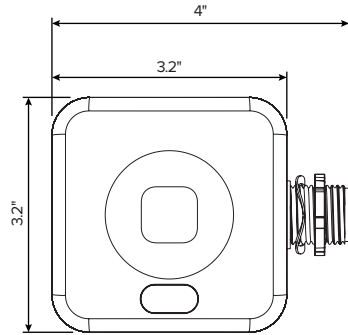

Coverage:

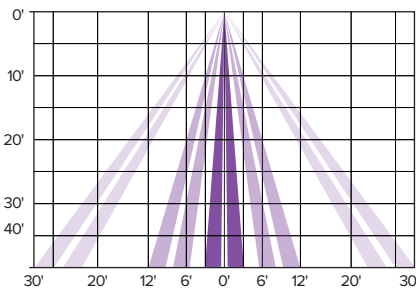

Side View Coverage

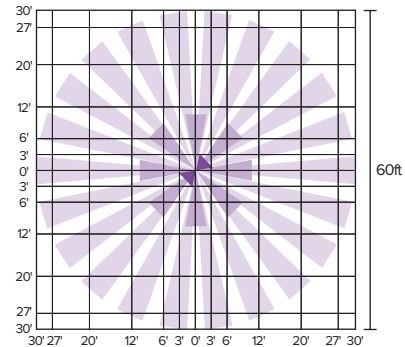

Top View Coverage

Wiring:

